

30 AG series

x30x08mm



General Specifications

- Motor : 4 Poles brushless DC motor
- Frame & Impeller : Plastic(UL 94V-0)
- Storage temperature : -40° to +75°
- Operating temperature : -10° to +70°

Major Characteristic Parameters

Model	*Bearing System	Rated Voltage	Operating Voltage Range	Rated Current	Rated Speed	Maximum Air Flow		Maximum Static Pressure		Sound Level	Weight
Part NO.	B / S / F	V	V	A	RPM	m ³ /min	CFM	mm-H ₂ O	In-H ₂ O	dBA	g
AGE03008_05L	B / S	5	4.5~5.5	0.12	6000	0.06	2.15	1.92	0.07	20.2	6
AGE03008_12L	B / S	12	7.0~13.2	0.10	6000	0.06	2.15	1.92	0.07	20.2	6
AGE03008_05M	B / S	5	4.5~5.5	0.20	8000	0.07	2.74	3.23	0.13	24.7	6
AGE03008_12M	B / S	12	7.0~13.2	0.10	8000	0.07	2.74	3.23	0.13	24.7	6
AGE03008_05H	B / S	5	4.5~5.5	0.25	10000	0.08	2.92	4.87	0.19	29.7	6
AGE03008_12H	B / S	12	7.0~13.2	0.12	10000	0.08	2.92	4.87	0.19	29.7	6

*Bearing system B: Two Ball Bearing F: Fluid Bearing S: Sleeve Bearing

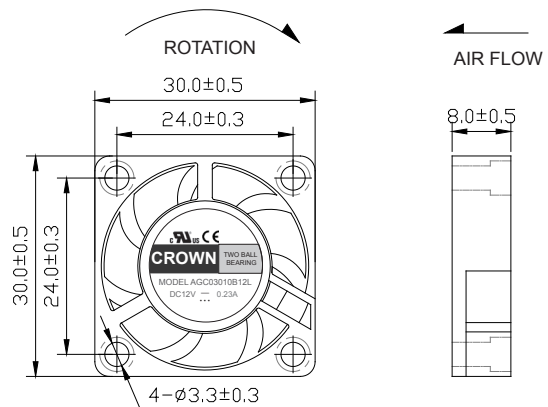
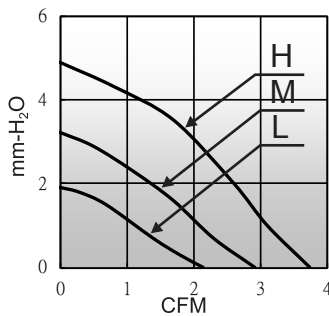

unit:mm